



Models : XD-1100.2 FR
XD-1400.2 FR
XD-5040.4 FR
XD-1800.1 MONO

Owner's Manual

INTRODUCTION

Amplifiers provide high-performance sound reinforcement for your mobile audio equipment. Its versatility enables compatibility with optional Equalizers, Frequency Dividing Network Crossovers, and other audio processors in a customized system. The Multi-Mode bridging capabilities allow flexibility in hosting several different speaker configurations.

To achieve optimum performance, We suggest that your stereo components are installed by an authorized dealer. It is highly recommended that you read this Owners Manual before beginning installation.

FEATURES - CLASS AB AMPLIFIER

- MOSFET POWER SUPPLY AMPLIFIER
- 12dB/Oct. CROSSOVER
 - VARIABLE HIGH PASS CROSSOVER (50Hz-500Hz) for 4CH 80Hz-1.2KHz for 2CH
 - VARIABLE LOW PASS CROSSOVER (50Hz-500Hz) for 4CH 50Hz-250Hz for 2CH
- VARIABLE 0dB TO 12dB BASS BOOST AT 45Hz
- DAISY CHAIN THROUGH OUTPUT RCA
- POWER AND PROTECTION LED
- 2 OHM STABLE CIRCUITS
- SOFT START / MUTE CIRCUIT
- TRIMODE OUTPUT CONFIGURATIONS

FEATURES - CLASS AB MONO AMPLIFIER

- MOSFET POWER SUPPLY AMPLIFIER
- 24dB/Oct. CROSSOVER
 - VARIABLE LOW PASS CROSSOVER (50Hz-250Hz)
- VARIABLE 12dB/Oct. SUBSONIC FILTER 20Hz - 50Hz
- VARIABLE PHASE SHIFT 0°- 180°
- VARIABLE 0dB TO 12dB BASS BOOST AT 45Hz
- BASS REMOTE CONTROL
- POWER AND PROTECTION LED
- 2 OHM STABLE CIRCUIT
- SOFT START / MUTE CIRCUIT

WARNING

High powered audio systems in a vehicle are capable of generating "Live Concert" high levels of sound pressure. Continued exposure to excessively high volume sound levels may cause hearing loss or damage. Also, operation of a motor vehicle while listening to audio equipment at high volume levels may impair your ability to hear external sounds such as; horns, warning signals, or emergency vehicles, thus constituting to a potential traffic hazard.

PLANNING YOUR SYSTEM

Before beginning the installation, consider the following:

- If you plan to expand your system by adding other components sometime in the future, ensure adequate space is left, and cooling requirements are met.
- Your Amplifier has been designed to accept Low-Level(Pre-Amp outputs from your radio) signal source.
If your radio/source is equipped with Pre-Amp outputs, it is possible to utilize them to drive the Amplifier and connecting(Amplifier) to the 2 rear speakers.
Then, use the built-in power of your radio to drive the 2 front speakers.
NOTE:
Distortion level is considerably lower from Pre-Amp (Low Level) outputs, than speaker(High Level) outputs.
- Are your components matched? The peak power rating of your speakers must be equal or greater than the Amplifier's. They also must be 2 - 8 Ohms impedance. *(This information is normally printed on the speaker magnet)*
- Consider both the length of your leads, and routing when determining the mounting location. Pre-Amp input Jacks require a length(depending on location) of high quality shielded male to male RCA patch cord.

MOUNTING YOUR AMPLIFIER

The mounting position of your Amplifier will have a great effect on its ability to dissipate the heat generated during normal operation. It has an ample heat sink for heat dissipation, and also designed with a thermal shut-down protection circuit, making it reasonably tolerant of mounting variations. Any configuration which allows moving air to be directed over the cooling fins will improve heat dissipation dramatically **DO NOT** enclose the amplifier in a small box or cover it so that air cannot flow around fins.

Temperatures in car trunks have been measured as high as 175°F(80°C) in the summer time. Since the thermal shut-down point for the Amplifier is 185°F(85°C), it is easy to see that it must be mounted for maximum cooling capability. To achieve maximum advantage of convection air flow in an enclosed trunk, mount the amplifier in a vertical position, on vertical surface.

MOUNTING SURFACE

Cooling requirements are considerably relaxed when mounting inside the passenger compartment since the driver will not often allow temperatures to reach a critical point. Floor mounting under the seat is usually satisfactory as long as there is at least 1 inch(2cm)above the Amplifier's fins for ventilation.

- Select a suitable location that is convenient for mounting, is accessible for wiring, and has ample room for air circulation and cooling.
- Use the amplifier as a template to mark the mounting holes. Remove the Amplifier and drill 6 holes. **USE EXTREME CAUTION, INSPECT UNDERNEATH SURFACE BEFORE DRILLING.**
- Secure the Amplifier using the screws provided.

CONNECTING THE POWER

CAUTION

AS A PRECAUTION, IT IS ADVISABLE TO DISCONNECT THE VEHICLE'S BATTERY BEFORE MAKING CONNECTION TO THE + 12 VOLT SUPPLY WIRING.

4 GAUGE(Thicker if planning for additional Amplifiers)wire is recommended for both the power and ground wires. 18 Gauge, for the remote turn-on wire. Both types available at most Mobile Audio Dealers or Installation Shops.

GROUND : To Vehicle Chassis

To avoid unwanted ignition noise caused by ground loops, it is essential that the Amplifier be grounded to a clean, bare, metal surface of the vehicle's chassis.

NOTE

GROUND WIRE SHOULD NOT BE EXTENDED MORE THAN 3 FT. (1 METER). USING THIS METHOD CAN CAUSE TURN ON AND TURN OFF TRANSIENTS (NOISE)

+12 Volt(Fused) Constant Power : To Battery (+)

Due to the power requirements of the Amplifier, this connection should be made directly to the positive (+) terminal of battery. For safety measures, install an in-line 50 Amp Fuse Holder (not included) as close to the battery positive (+) terminal as possible .
With an ampere rating not to exceed total value of fuses in amp.

Remote Turn-On Input : To Power Antenna output of Car Stereo

This Amplifier is turned "ON" remotely when the vehicle's stereo is turned "ON".

NOTE

IF YOUR RADIO DOES NOT HAVE A +12 VOLT OUTPUT LEAD WHEN THE RADIO IS TURNED ON, "RMT" TERMINAL ON THE AMPLIFIER CAN BE CONNECTED TO VEHICLE'S ACCESSORY CIRCUIT THAT IS LIVE WHEN THE KEY IS "ON".

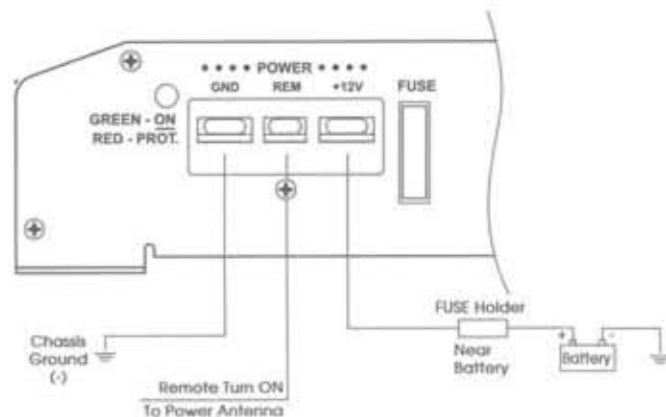

OPERATION

2CH

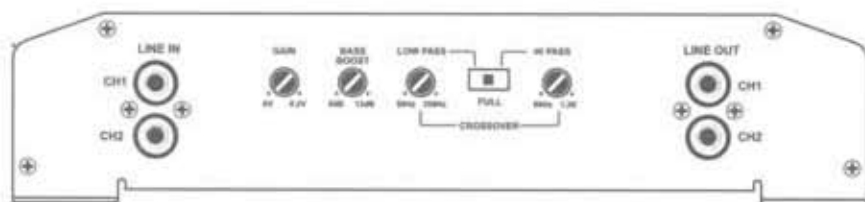

4CH

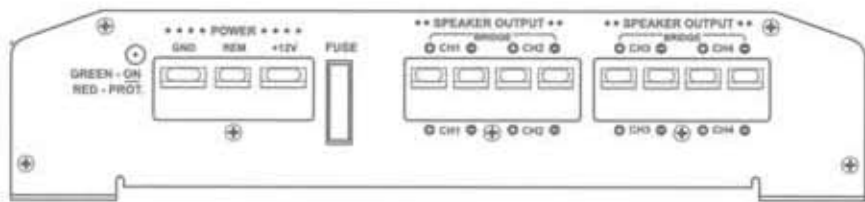
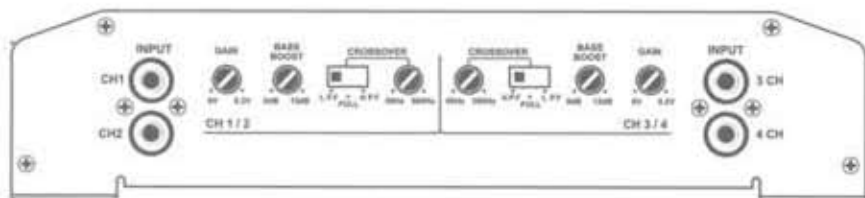

OPERATION

4CH

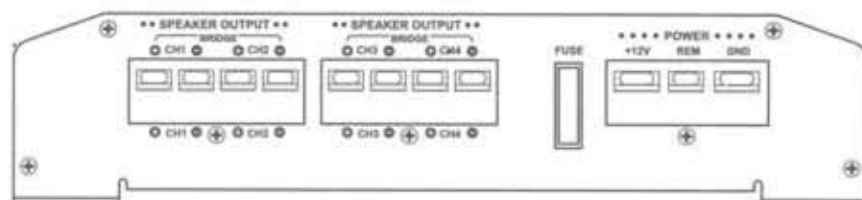

MONO

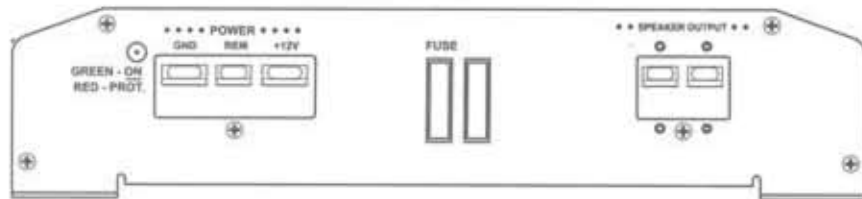
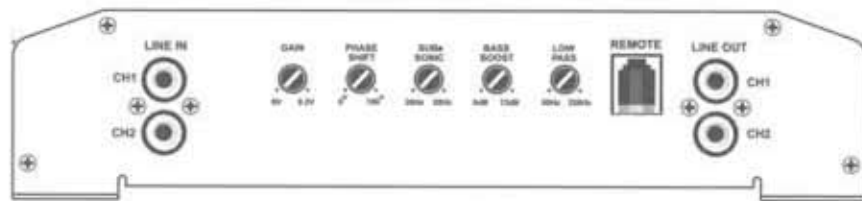

OPERATION

- **RCA Low Level Input Jacks**
It allows left and right inputs to be connected to the amplifier using RCA plugs.
- **RCA Line Output Jacks**
Full range output from channel L&R Inputs is provided at Line Out Jacks.
- **Input Level Control**
It allows for the adjustment of the gain of both channels to match the output level of the source. In addition, it allows for detailed adjustment with L&R level control to be separated.
- **Subsonic Filter**
It admits of removing the frequency below 20Hz to 50Hz using the Subsonic(Mono Ch) Variable Control in order to protect subwoofer speaker or to produce powerful subwoofer sound.
- **Bass Boost**
Adjust the sub boost level of the selected frequency output from 0dB to 12dB.
- **Variable Highpass controls**
Adjust the crossover frequency of the-High Pass output only, from 50Hz to 500Hz(4ch) 80Hz to 1.2KHz(2CH)
- **Variable Lowpass controls**
 - 2Ch & 4Ch
50Hz to 250Hz(2CH) Adjust the crossover frequency of the LOW Pass output only, from 50Hz to 500Hz(4CH).
 - Mono Ch
Adjust the crossover frequency of the LOW Pass from 50Hz to 250Hz.
- **Variable Phase shift**
Variable Phase shift 0° to 180°
- **Amplifier X-over switch / Line outs X-over switch for 2Ch & 4Ch**
 - a) LPF : Allows for the control of the low pass frequency range
 - b) FULL : Allows for full range pass through.
 - c) HPF : Allows for the control of the high pass frequency range
- **Power LED**
It indicates when amplifier is on and no fault existence.
- **Protection LED**
It illuminates when fault condition exists, and amplifier immediately shuts down. If illuminated, turn amplifier off, check for shorted speaker leads and DC noise from RCA input and attempt to re-power amplifier.
- **Speaker Terminal**
It allows the connection of speakers to the amplifier.
- **Fuse**
It protects both the amplifier and automobile electrical system from fault conditions.

OPERATION

- **Power connection**
Connects +12VDC power wire from the battery.
- **Remote connection**
Connects the control wire which allows the amplifier to be turned on and off by the radio cassette player.
- **Connects ground wire from a suitable ground point on the chassis.**
- **Remote Gain Control**
you can control Remote Gain, connecting the Remote control to Amplifier.

TROUBLESHOOTING

Before removing your Amplifier, refer to list below and follow suggested procedure. Speakers and their wires should be tested first.

No Output:

- Confirm that all terminal strip connections are firmly connected.
- Check in-line and built-in fuses. Both "+12V" and "RMT" terminals must have +12 Volts to chassis ground.
- Confirm that signal source (*Car Radio/Deck, EQ, X-over etc.*) is connected and is supplying output signal.

To confirm that Amplifier is working, connect an RCA patch cord to LEFT & RIGHT low-level inputs of Amplifier only (*Do not connect the other end of the patch cord*). Briefly tap the center pin of each (*disconnected*) RCA plug on the other (*disconnected*) end with your finger. This should produce a noise (*feedback*) in the speakers.

Only One Channel works:

- Confirm that speaker terminal strip connections are firmly connected.
- Check "BALANCE" control on Car Stereo (*or signal source*) to verify it is at mid-point.
- If using RCA Low-Level inputs, reverses the input plugs at the Amplifier (*right to left or vice versa*).

If the channel that is silent reverses position, the problem is in the Car Stereo (*EQ, X-over, or other signal source*) or connecting cable.

SPECIFICATIONS

CLASS 2, 4CH.

SPEC. \ MODEL	XD-1100.2 FR	XD-1400.2 FR	XD-5040.4 FR
POWER OUTPUT DC(14.4V)			
RMS AT 4 Ohm	55W X 2CH	120W X 2CH	55W X 4CH
RMS AT 2 Ohm	75W X 2CH	170W X 2CH	75W X 4CH
RMS AT 4 Ohm , MONO	130W X 1CH	330W X 1CH	130W X 2CH
MAX POWER	1100W	1400W	1400W
S/N RATIO	> 95dB	> 95dB	> 95dB
THD (IHF-A)	0.05%	0.05%	0.05%
CHANNEL SEPARATIONS	> 50dB	> 50dB	> 50dB
INPUT SENSITIVITY	0.2V - 6V	0.2V - 6V	0.2V - 6V
INPUT IMPEDENCE	20 KOhm	20 KOhm	20 KOhm
SLEW RATE	10V / μ Sec	10V / μ Sec	10V / μ Sec
DAMPING FACTOR	> 100	> 100	> 100
FUSE RATING	20A x 1 EA	20A x 1 EA	40A x 1 EA
DIMENSION(mm)			
• WIDTH	240.0mm	240.0mm	240.0mm
• HEIGHT	53.0mm	53.0mm	53.0mm
• LENGTH	200.0mm	280.0mm	280.0mm

CLASS AB MONO

SPEC. \ MODEL	XD-1800.1 MONO
POWER OUTPUT DC(14.4V)	
RMS AT 4 Ohm	245W X 1CH
RMS AT 2 Ohm	450W X 1CH
MAX POWER	1800W
S/N RATIO	> 95dB
THD (IHF-A)	0.05%
CHANNEL SEPARATIONS	> 50dB
INPUT SENSITIVITY	0.2V - 6V
INPUT IMPEDENCE	20 KOhm
SLEW RATE	10V / μ Sec
DAMPING FACTOR	> 100
FUSE RATING	25A x 2 EA
DIMENSION(mm)	
• WIDTH	240.0mm
• HEIGHT	53.0mm
• LENGTH	325.0mm